

Partial Resonant ac Link Converters

H. A. Toliyat

Abstract: In this paper, a soft switched high frequency ac link converter is studied as an alternative to dc link converters. The proposed configuration overcomes the disadvantages of dc link converters and offers an efficient, light weight, reliable converter with unity power factor and low current total harmonic distortion (THD). It employs 12 bi-directional switches interfacing with a partially resonating ac link consisting of an inductor and a small capacitor in parallel. The capacitor produces soft turn-off under all operating conditions, and the control method guarantees zero voltage turn-on of the switches. As a result of its near zero switching power losses, this converter is capable of operating at high frequencies, which will result in smaller link inductor and filter elements. These characteristics make this converter an outstanding alternative to dc link converters. This paper will evaluate the performance of the proposed converter in the context of several potential applications.

Keywords: Terms—resonant converter, ac link converter, soft switching.

1. Introduction

Variable frequency drives typically employ dc voltage or current links for power distribution between the input and output converters and as a means of temporarily storing energy. The dc link based power conversion systems have several inherent limitations, among the most important of which are the high switching losses and high device stresses that occur during switching intervals. These issues severely reduce the practical switching frequencies. Additionally, while the cost, size, and weight of the basic voltage sourced PWM drive is attractive, difficulties with input harmonics, output dV/dt and over-voltage, EMI/RFI, tripping with voltage sags, and other problems significantly diminish the economic competitiveness of these drives. Add-ons are available to mitigate these problems, but may double or triple the total costs and losses, with significant accompanying increases in volume and weight.

This paper presents an alternate topology that not only accomplishes the same function as the dc link converter, but which also overcomes its drawbacks. The converter proposed in this paper is a high frequency partial resonant link converter.

High frequency link power converters are receiving

increasing attention as an alternative to more conventional dc link power conversion systems. Use of a high frequency ac voltage link in a power conversion system permits adjustment of the link voltage to meet the individual needs of loads/source in the system. By operating the link at a high frequency, the system can be made compact due to the large reduction in the size of passive components needed for filtering and temporary energy storage. High frequency operation also speeds up the system response and, if the frequency is above the audible range, reduces acoustic noise [1].

A high-frequency link offers the flexibility of adjusting the link voltage to meet the individual needs of the source and load while simultaneously providing isolation between the two sides [1]. High frequency link power conversion has been employed very successfully in dc-dc converters [2-5]. This demonstrated the advantages and also the difficulties in working with high frequency links, such as problems associated with circuit topologies and device capabilities. As a result of increased demand and advancements in semiconductor technology, switches specifically designed for high frequency applications are becoming available. The use of resonant circuits in high frequency dc-dc converters has since been reported [6].

Ac-ac and dc-ac converters employing high frequency ac links have also been reported in [7-10]. Most of these converters are designed for specific types of source/loads. Reference [1] reported a resonant converter that provides one-step bidirectional power conversion for different kinds of loads/sources. This configuration uses bidirectional switches and employs pulse density modulation (PDM) as a means of controlling the currents. The application of PDM reduces the system response due to use of integral pulses of currents. Reference [11] proposes a topology with unidirectional switches. This topology is in fact a conventional soft-switched “partial resonant” converter. However, its operational response is limited due to an inability to supply output current at low voltages or power factors, while using link frequencies high enough to avoid input/output filter resonances. Also, there is a large dead time due to the resonant ‘fly back’ which reduces the power capability by about 30%. This largely negates its advantage of using fewer switches than the proposed topology [12].

This paper proposes a new soft switched “partial resonant” ac link converter that overcomes the aforementioned drawbacks while offering superior control capabilities and significant economic advantages. The effectiveness of partial resonance is shown in [13-19]. In section II, the proposed converter topology and its principle of operation are presented.

A number of applications for this converter are presented with Psim simulation results in section III. Finally, section

Manuscript received November 26, 2012, revised December 12, 2012.

H. A. Toliyat is with the Department of Electrical and Computer Engineering, Texas A&M University, USA. The correspondent author's email is: toliyat@tamu.edu

IV contains a concluding overview of the work presented herein.

2. Principle of Operation

Fig. 1 shows a schematic of the proposed topology, in which the link is formed by a low reactive rating inductor-capacitor pair. All power transfer goes through the link inductor in a completely indirect means. Each leg of the converter is made of 2 bidirectional switches, realized by anti-series IGBT/diodes. As shown in this figure, six bi-directional switches interface a link inductor to the output, while another 6 bi-directional switches interface the same link inductor to the input. The converter transfers power entirely through the link inductor.

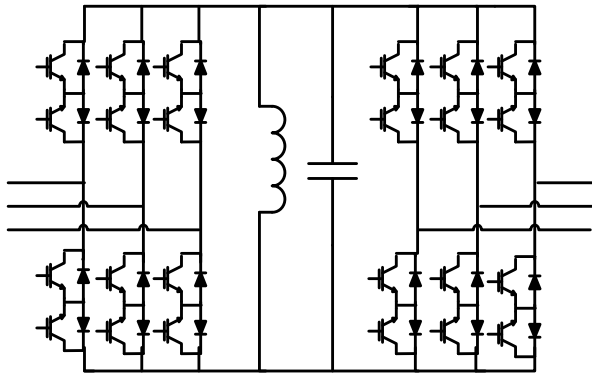

Fig. 1. Proposed partial resonant ac link converter.

Charging and discharging take place alternately. The frequency of charge/discharge is called the link frequency and is typically much higher than the input/output line frequency. The resulting input and output current pulses have to be precisely modulated such that when filtered, they achieve unity power factor at the input while meeting the output references. Normally, the instantaneous values of the input current commands are in phase or are phase adjusted with respect to the input voltages so as to achieve unity power factor.

All turn-ons happen at zero voltage and turn off losses are low because of the capacitive buffer across the switches. The converter is essentially a PWM current source; although, all link currents are ac with no dc offset.

During the charging modes, the link current rises to a peak value determined by the amount of power to be transferred. Charging is done via two input phase pairs (during modes 1 and 3) which are nominally the lines having the highest and the second highest instantaneous voltages (for unity power factor). The charged link discharges into two output phase pairs similar to the inputs. Charging (discharging) currents are controlled in nanosecond increments to produce precisely the correct charging (discharging) and eliminate all harmonics below the power cycle frequency, which is twice the link frequency. Partial resonance occurs between the power transfer modes. During the partial resonance modes, appropriate switches are enabled and turn on as they

become forward biased, as with a diode, resulting in low turn-on losses. The link capacitor results in low-loss soft turn-off of the switches and does not introduce any additional losses. The low switching losses allow the use of slower and higher current density switches, possibly with soft switched optimized structures, or alternatively, higher link frequencies. Figs. 2 and 3 show the basic operating modes and relevant converter waveforms, respectively.

Each link cycle is divided into 16 modes, with 8 power transfer modes and 8 partial resonance modes taking place alternatively. For a 15 kW, 460 V converter, the link oscillates at about 10 kHz. Power is transferred twice during each link cycle. This is roughly at 20 kHz, thereby resulting in superior control and reduced filtering requirements. Zero voltage turn-on and capacitance buffered turn-off enable operation at this frequency. Medium voltage converters employing this topology are expected to have a link frequency of about 2.5 kHz.

There are three basic operations taking place through the 16 modes: energizing, partial resonance, and de-energizing. Modes 2, 4, 6, 8, 10, 12, 14 and 16 are the partial resonance modes and as evident from Fig. 3, they make up only a very small fraction of the link cycle time. The link is energized from the inputs during modes 1, 3, 9 and 11 and is de-energized to the outputs during modes 5, 7, 13 and 15. The various operating modes are explained below:

A. Mode 1 (Energizing)

The link is connected to the input phase pair with the highest voltage via switches which charge it in the positive direction. For the waveforms shown in Fig. 3, the link is connected to the input phase pair BC through switches S_{3i} and S_{2i} . The link charges until I_{bi} , averaged over a cycle time, meets its reference value. The switches are then turned off.

B. Mode 2 (Partial resonance)

The link capacitance acts as a buffer across the switches during turn off. This results in low turn off losses. All switches remain turned off and the link resonates until its voltage becomes equal to that of the input phase pair having the second highest voltage. This is the phase pair which charges the link next. In the example shown in Fig. 3, the link resonates until the link voltage becomes equal to V_{aci} .

C. Mode 3 (Energizing)

Switches are turned on to allow the link to continue charging in the positive direction from the input phase pair with the second highest voltage. At the end of mode 2, the link voltage equals the voltage of this phase pair. Hence at the instant of turn on, the voltage across the corresponding switches is zero. This implies that the turn on occurs at zero voltage as the switches transition from reverse to forward bias. In the example in Fig. 2, the link charges until I_{ci} , averaged over a cycle time, meets its reference value. The switches are then turned off.

D. Mode 4 (Partial resonance)

During this mode the link is allowed to swing to one of the output line voltages. The sum of the output reference currents at any instant is zero, as one of them is the highest in magnitude and of one polarity while the two lower magnitude ones are of the opposite polarity. The converter uses this simple property to avoid any resonant swing back in the link. The charged link transfers power to the output by discharging into two output phase pairs. The two phase pairs are the one formed by the phases having the highest reference current and the second highest reference current, and the one formed by the phases having the highest reference current and the lowest reference current, where the references are sorted as highest, second highest and lowest in terms of magnitude alone.

E. Mode 5 (De-energizing)

The output switches are turned on at zero voltage to allow the link to discharge to the chosen phase pair. Once the current of phase A (for the case shown in Figs. 2 and 3) meets its reference, the switches are turned off and another resonating mode is initiated.

F. Mode 6 (Partial resonance)

All switches are turned off and the link is allowed to swing to the voltage of the other output phase pair chosen during Mode 4. For the example discussed before, the link voltage swings from V_{aco} to V_{bco} . This is also illustrated in Fig. 3.

G. Mode 7 (De-energizing):

During mode 7, the link discharges to the selected output phase pair until there is just sufficient energy left in the link to swing to the input phase pair with the highest voltage.

H. Mode 8 (Partial resonance)

The link swings to the input phase pair with the highest voltage and is thereby ready to charge the link in the reverse direction. Modes 9 through 16 are similar to modes 1 through 8, except that the link charges and discharges in the reverse direction. For this, the complimentary switch in each leg is switched when compared to the ones switched during modes 1 through 8. The input is never directly connected to the output, resulting in proper isolation between the two sides. Fully galvanic isolation can be achieved by using an isolation transformer in place of the link inductor. The converter can operate without the link capacitor; however, since the topology is tolerant to such capacitance, a low cost, light weight, and efficient link inductor with high parasitic capacitance can be used.

This converter can also be used as an ac-dc, dc-ac or dc-dc converter. The principle of the operation is similar to that of an ac-ac converter except that the charging and discharging of the dc side is fulfilled in one mode instead of two modes.

3. Different Applications of Proposed converter and Simulation Results

A. Wind application

The proposed converter can be employed in a wind generation application (ac-ac converter), involving either direct driven wind generators, such as permanent magnet generators, or indirect driven technologies, such as doubly fed induction generators. Fig. 4 depicts the schematic of this converter. A 30 kW ac to ac converter was designed for wind applications and simulated in Psim. Figs. 5 and 6 depict the filtered input and output currents, respectively and, as can be seen, they have a low THD (less than 4%). Due to the high frequency of the link, the size of the filter elements is small. The link current and voltage are depicted in Fig. 7. The link inductor current is positive in one half cycle and negative in the other half cycle, which results in better inductor utilization.

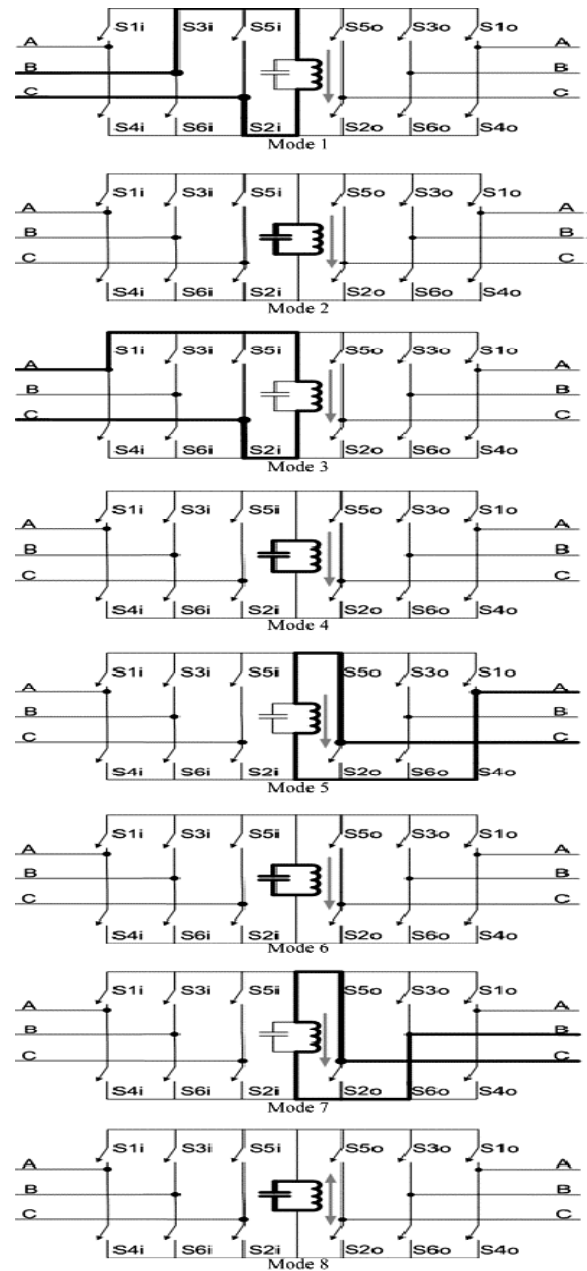

Fig. 2. Circuit behavior in different modes.

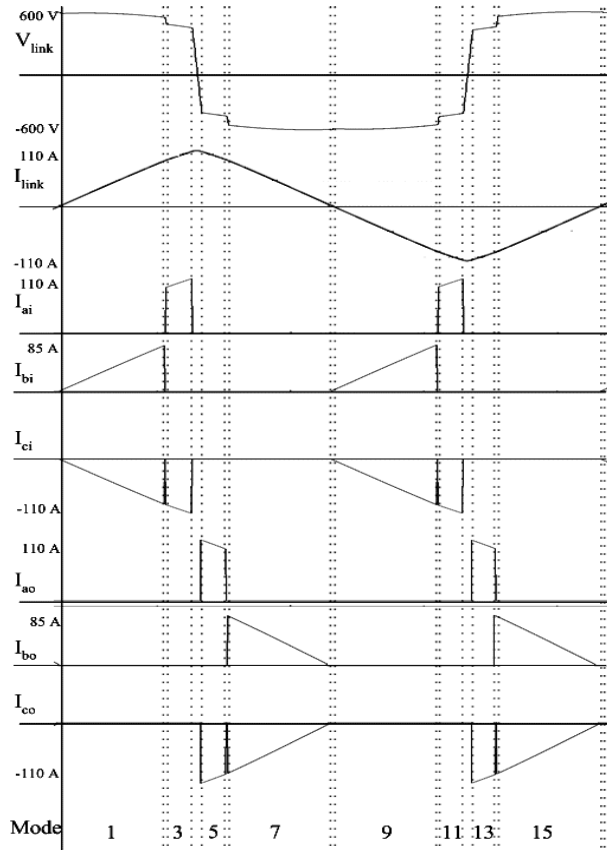

Fig. 3. Waveforms in different modes of operation.

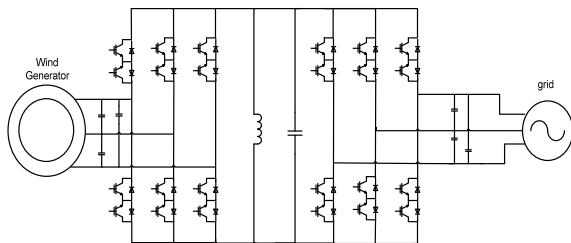

Fig. 4. Proposed converter employed in wind application.

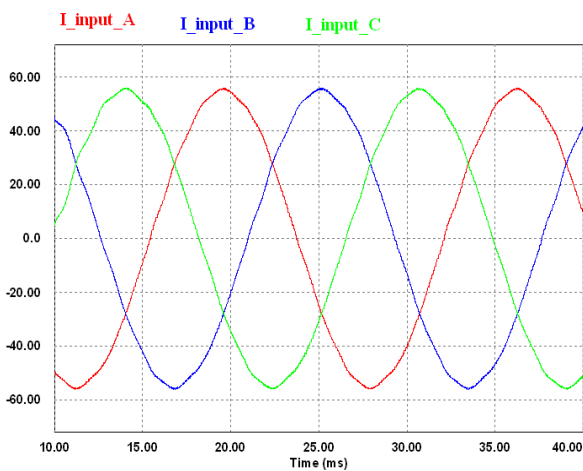

Fig. 5. Input currents.

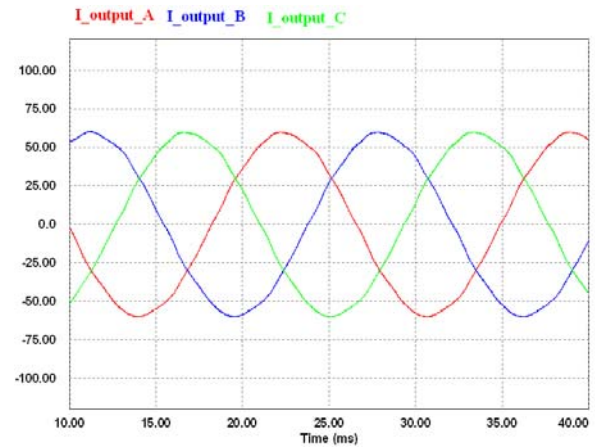

Fig. 6. Output currents.

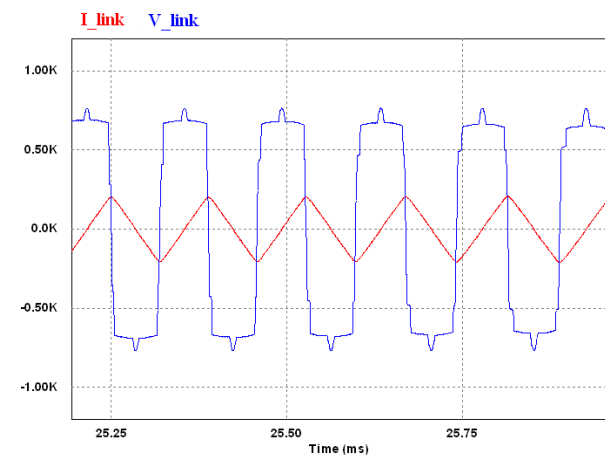

Fig. 7. Link voltage and current.

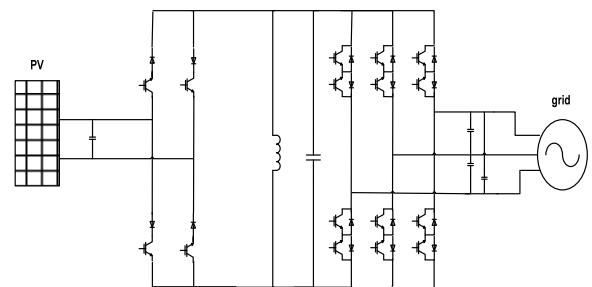

Fig. 8. Proposed converter employed in pv application.

B. Solar application

Another use of the proposed converter is solar power applications. This converter can be employed to convert dc power from solar cells to ac power. Fig. 8 represents the schematic of this converter. Due to the uni-directional nature of the current at the photovoltaic (PV) side, the switches are uni-directional. A 30 kW system is simulated in Psim. Figs. 9 and 10 show the filtered input and output currents, respectively.

C. Battery utility application

Another application of the proposed converter is a battery-utility interface. In order to provide the required grid stabilization, power converters used in this application must be capable of switching between charging batteries and

supplying power to the electric grid in a matter of a few milliseconds. Additionally, this must be accomplished at low cost with high power level converters.

The proposed partial resonant ac link converter is capable of such rapid switching speeds, due to its high frequency of internal operation. Power reversal speed is only limited by the resonance period of the input/output filters, which have small per unit reactance due to the current sourced nature of the converter and its high frequency of internal operation.

Power reversal times of less than 0.5 ms are demonstrated by simulation. Fig. 11 represents the schematic of the converter for this application, which will operate as both a dc-ac converter and an ac-dc converter. A 25 kW converter was simulated in PSim and the results are presented in Figs. 12 and 13. These figures depict the dc side and ac side currents, respectively. Power reversal occurs at 18 ms. As seen in the simulation results, the power reversal process duration is less than 0.5 ms.

converters and offers a high efficiency, light weight, reliable alternative with low current total harmonic distortion (THD). In this paper, the principle of operation of the proposed converter is described in detail. Moreover, a number of applications are presented along with simulation results to show the variety of areas in which this converter can be used.

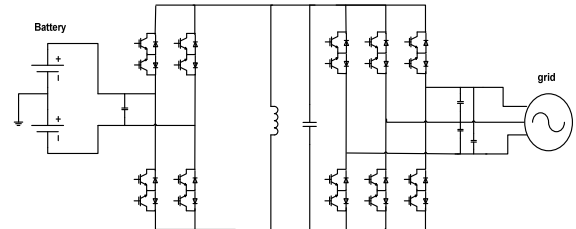

Fig. 11. Proposed converter as a battery-utility interface.

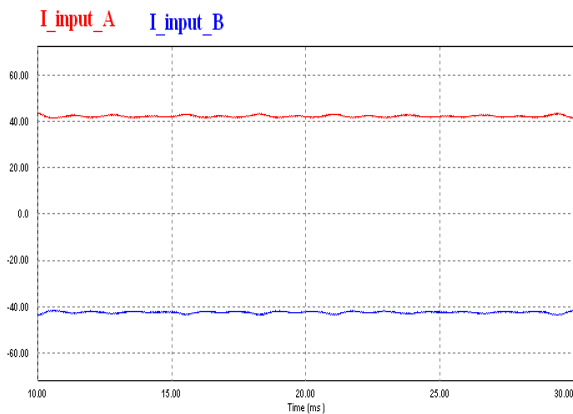

Fig. 9. PV side current.

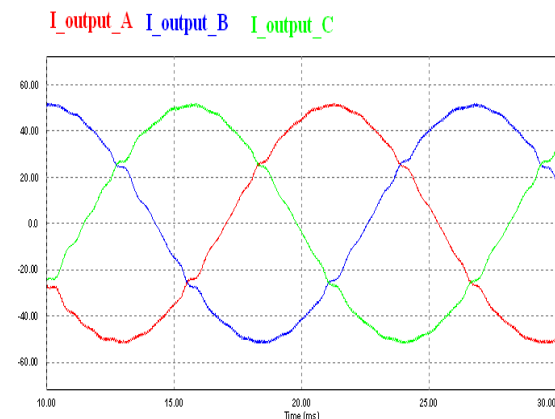

Fig. 10. The ac side current.

Conclusion

In this paper, a soft switched high frequency ac link converter is proposed as an alternative to dc link converters. The proposed converter, which is a partial resonant converter, overcomes the disadvantages of dc link

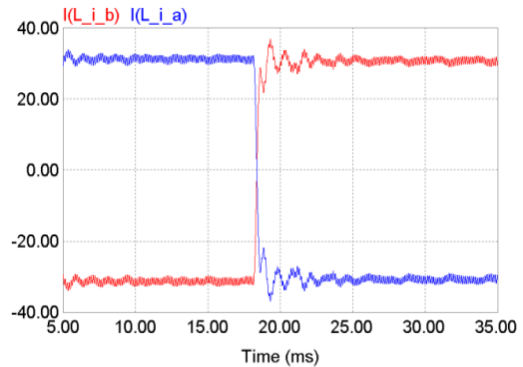

Fig. 12. The dc side currents.

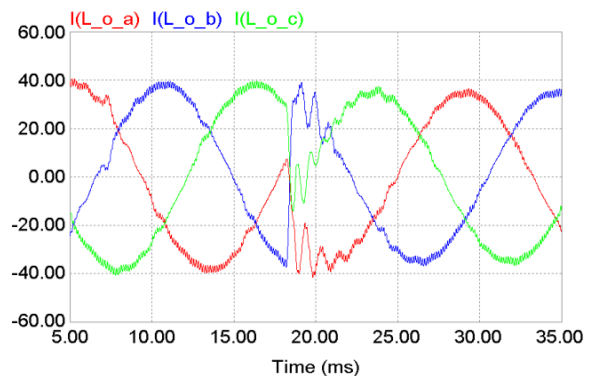

Fig. 13. The ac side currents.

Acknowledgment

The author would like to thank his Ph.D. students Ms. Mahshid Amirabadi and Mr. Matthew Johnson in preparing this manuscript.

References

[1] P.K. Sood and T.A. Lipo, "Power conversion distribution system using a high-frequency AC link," *IEEE Transactions on Industry Applications*, vol. 24, pp. 288-300, 1988.
 [2] G. Kassakian, A.F. Goldberg, and D.R. Moretti, "A comparative evaluation of series and parallel structures

- for high frequency transistor inverters," in *Conf. Rec. 1982 Ann. Meeting IEEE Power Electronics Specialists*, pp. 20-26.
- [3] R. Myers and R.D. Peck, "200-kHz power FET technology in new modular power supplies," *Hewlett-Packard J.*, pp. 3-10, Aug. 1981.
- [4] V. T. Ranganathan, P.D. Ziogas, and V.R. Stefanovic, "Performance characteristics of high frequency links under forward and regenerative power flow conditions," in *Conf. Rec. 1983 IEEE Znd Appl. SOC, Ann. Meeting*, pp. 831-837.
- [5] F.C. Schwartz, "An improved method of resonant current pulse modulation for power converters," *IEEE Transactions on Industrial Electronics and Control Instrumentation*, vol. IECI-23, pp. 133-141, May 1976.
- [6] R. L. Steigerwald, "High-frequency resonant transistor dc-dc converters," *IEEE Transactions on Industrial Electronics*, vol. IE-31, pp. 181-191, May 1984.
- [7] H. Huisman and S.W.H. de Haan, "A dc to 3-phase series resonant converter with low harmonic distortion," *IEEE Transactions on Industrial Electronics*, vol. IE-32, pp. 142-149, May 1985.
- [8] J. B. Klaasens, "DC to ac series-resonant converter system with high internal frequency generating synthesized waveforms for multikilowatt power levels," *IEEE Transactions on Power Electronics*, vol. PE-1, no.1, pp. 9-20, Jan. 1986.
- [9] V.T. Ranganathan, P.D. Ziogas and V.R. Stefanovic, "A dc-ac power conversion technique using twin resonant high-frequency links," *IEEE Transactions on Industry Applications*, vol. IA-19, pp. 393-400, May/June 1983.
- [10] F.C. Schwartz, "A double sided cycloconverter," *IEEE Transactions on Industrial Electronics and Control Instrumentation*, vol. IECI-28, pp. 282-291, Nov. 1981.
- [11] I.-D. Kim and G.-H. Cho, "New bilateral zero voltage switching ac/ac converter using high frequency partial-resonant link," *Industrial Electronics Society*, 1990. IECON '90, 16th Annual Conference of IEEE, pp. 857-862, vol. 2, Nov. 1990.
- [12] W.C. Alexander, "Universal Power Converter," US patent 2008/0013351A1, Jan. 17, 2008.
- [13] H.A. Toliyat, A. Balakrishnan, M. Amirabadi, and W.C. Alexander, "Soft switched ac-link AC/AC and AC/DC buck-boost converter," *Power Electronics Specialists Conference*, 2008, PESC 2008, IEEE, pp. 4168-4176, 15-19 Jun. 2008.
- [14] M. Amirabadi, H.A. Toliyat, and W.C. Alexander, "Battery-utility interface using soft switched AC link buck boost converter," *Electric Machines and Drives Conference*, 2009. IEMDC '09. IEEE International, pp. 1299-1304, 3-6 May 2009.
- [15] M. Amirabadi, H.A. Toliyat, and W.C. Alexander, "Battery-utility interface using soft switched ac link supporting low voltage ride through," *Energy Conversion Congress and Exposition*, 2009, IEEE, pp. 2606-2613, 20-24 Sep. 2009.
- [16] A. K. Balakrishnan, "Soft Switched High Frequency ac-Link Converter," M.S. Thesis, ECE Dept., Texas A&M Univ., College Station, TX, 2008.
- [17] M. Amirabadi, A. Balakrishnan, H. A. Toliyat, W. Alexander, "Soft switched ac-link direct-connect photovoltaic inverter," in *Proc. IEEE Int. Conf. on Sustainable Energy Technologies*, 2008, pp. 116-120.
- [18] A. K. Balakrishnan, H. A. Toliyat, and W. C. Alexander, "Soft switched ac link buck boost converter," in *Proc. Applied Power Electronics Conference and Exposition (APEC)*, 2008, pp. 1334-1339.
- [19] A. K. Balakrishnan, M. Amirabadi, H. A. Toliyat, and W. Alexander, "Soft switched ac-link wind power converter," in *Proc. IEEE International Conference on Sustainable Energy Technologies (ICSET)*, 2008, pp. 318-321.

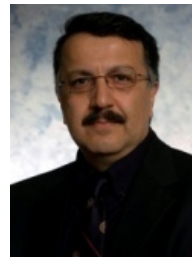

Hamid A. Toliyat received the B.S. degree from Sharif University of Technology, Tehran, Iran in 1982, the M.S. degree from West Virginia University, Morgantown, WV in 1986, and the Ph.D. degree from University of Wisconsin-Madison, Madison, WI in 1991, all in electrical engineering. Following receipt of the Ph.D. degree,

he joined the faculty of Ferdowsi University of Mashhad, Mashhad, Iran as an Assistant Professor of Electrical Engineering. In March 1994 he joined the Department of Electrical and Computer Engineering, Texas A&M University where he is currently Raytheon endowed professor of electrical engineering.

Dr. Toliyat's main research interests and experience include analysis and design of electrical machines, variable speed drives for traction and propulsion applications, fault diagnosis of electric machinery, and sensorless variable speed drives. Prof. Toliyat has supervised more than 50 graduate students, published over 385 technical papers (over 115 papers are in IEEE Transactions), presented more than 80 invited lectures all over the world, and has 13 issued and pending US patents. He is the author of DSP-Based Electromechanical Motion Control, CRC Press, 2003, the co-editor of Handbook of Electric Motors - 2nd Edition, Marcel Dekker, 2004, and the co-author of Electric Machines – Modeling, Condition Monitoring, and Fault Diagnosis, CRC Press, Florida, 2013.